

Quick Start Guide

WIFI NVR KIT
Version: 1.0

Overview

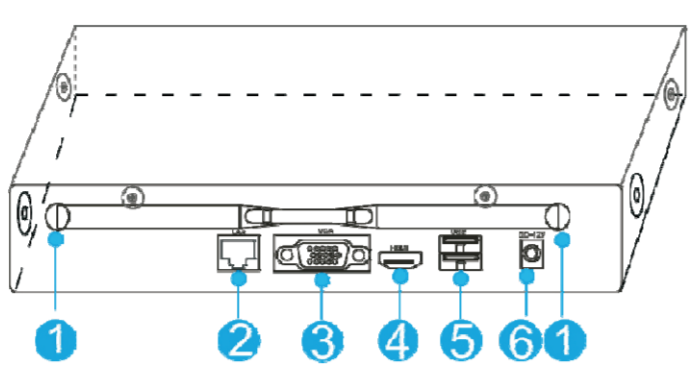

S/N	name	Description
1	Antenna	Install antenna
2	LAN	Connect to LAN or external network
3	VGA	Connect a VGA monitor
4	HDMI	Connect an HDMI display
5	USB	Connect to operate mouse or U disk
6	Power	Connect 12V2A power adapter

1

Installation and Connection

- 1. Note the following when installing and using:**
- 1.1. In order to extend the life of the machine, the machine should be kept away from water, high temperature and dusty environment, and placed in a well-ventilated place.
 - 1.2. Please use SATA hard drives, USB devices, and mouse devices purchased through regular channels.
 - 1.3. Before use, please make sure that the network HD recorder is properly grounded and the power supply cannot exceed the normal operating voltage range of the power supply.

2. Preparation Before Installation:

- 2.1. Determine where to place the NVR**
- It is recommended to put the NVR in the center of the surveillance area, and avoid obstacles between the IPC (wireless camera) installation location and the NVR. When 4 channels of video are connected at the same time, when there is no obstacle between NVR and IPC, IPC is placed in

2

Installation and Connection

- the spherical coverage area with NVR as the center of the sphere and a radius of 100-120 meters. If blocked by wall, it will reduce the radius to 30-50 meters
- 2.2. Connection steps**
- Install the hard disk to the NVR, as shown in the figure, after the installation is complete, first connect the NVR to the mouse and the display, turn on the power, and connect the power to the IPC.
- (1) Using a screwdriver, remove the top cover;

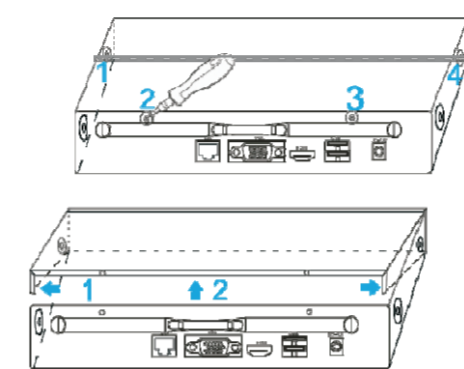

- (2) Install the hard disk data cable and power cable, and

3

Installation and Connection

- tighten the screws:
- (3) Confirm that the wireless NVR package is working properly

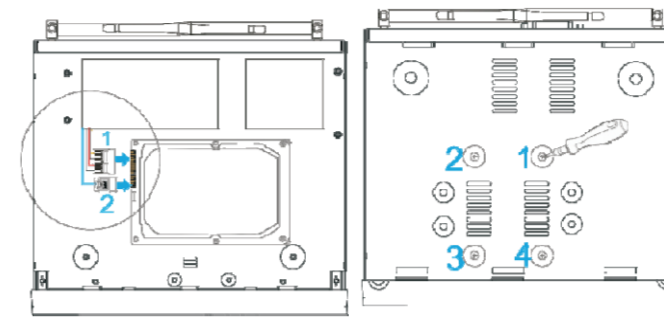

The NVR is connected to the monitor, and all supporting IPCs are placed around the NVR. Can be installed to a predetermined location.

3. Camera is Placed in a Preset Position:

- 3.1. Install the wireless camera to the preset position within the effective coverage of the wireless signal and provide 12V power supply;
- 3.2. When the wireless camera is powered on for about 1

4

Installation and Connection

- minute, you can see the video on the NVR monitor;
- 3.3. If there is no image, it indicates that the distance is too far, the distance needs to be shortened.

NVR antenna transmits signals to the surroundings. The NVR and IPC antennas are at the same height and parallel to each other. The best effect is if the antennas are not at the same height. The IPC antenna should be tangent to the spherical surface with the NVR as the center (Figure 6) Point directly to the NVR (Figure 7)

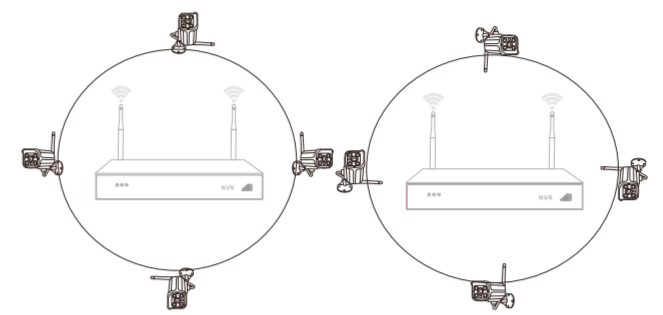

5

Boot

Note:

Please confirm that the connected voltage matches the requirements of the hard disk recorder, and ensure that the ground terminal of the hard disk recorder is well grounded. When the power supply is abnormal, it will cause the hard disk recorder to not work normally, or even damage the hard disk recorder. It is recommended to use a regulated power supply.

Explanation: Before turning on, please make sure that a monitor or monitor is connected to the video output port of the device.

Specific boot steps are as follows:

1. Plug in the power supply, the power indicator on the front panel is red
2. Device starts to boot, the boot screen is the boot screen is as shown:

6

Boot

3. After the system is turned on and started, after the system is initialized, the system automatically displays the image preview interface. The login interface pops up automatically after the user's operating system. As shown below. The user needs to complete the login before proceeding.

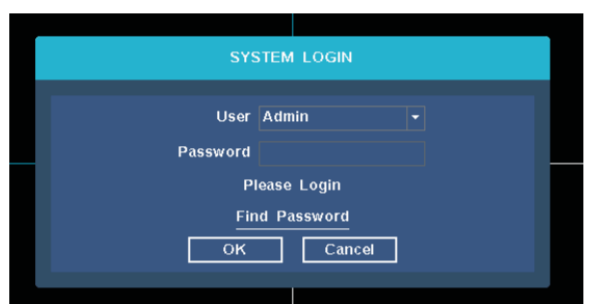

7

Boot

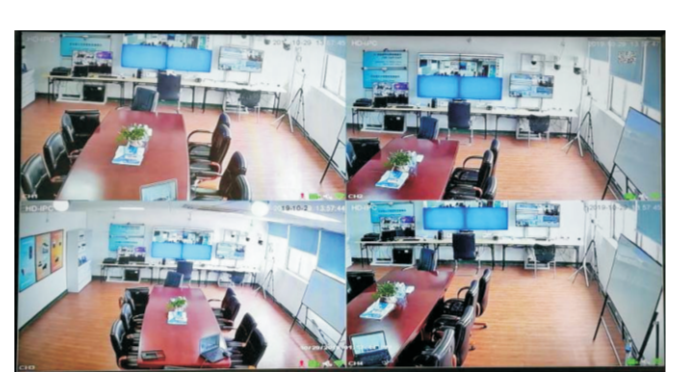

Steps:

1. Click the user name edit box with the left mouse button, and enter the user name of the local login, default factory set user name is admin.
2. Click the password edit box with the left mouse button, and enter the password for local machine login, the default factory-set password is admin.
3. Click "OK" with the left mouse button to complete the login.

8

Boot

Explanation:

Password can be composed of numbers, characters, operators and dots, *, #, and the length cannot exceed 12 characters.

pls attention: If you forget your password. You can click to retrieve the password, the system will automatically generate a random number, send the random code to the customer service of the supplier, and request a new login password, as shown in the following figure:

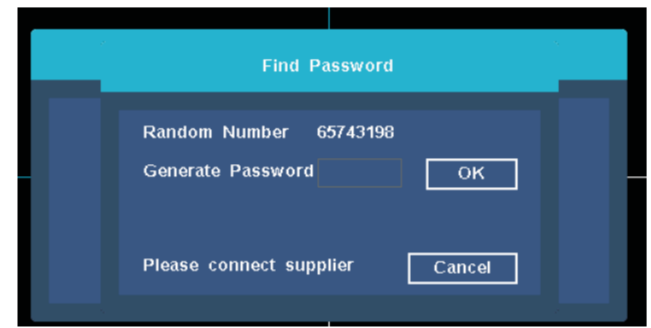

9

IPC Pairing

1. IPC Pairing Status

Function Description: Check the status of the IPC channel and whether it is connected.

Steps: Right-click the main interface of the system, click the [Pair IPC] submenu in the pop-up right-click menu, enter the IPC pairing interface, and view the status of the IPC channel. You can view the channel connection and channel status. As shown below:

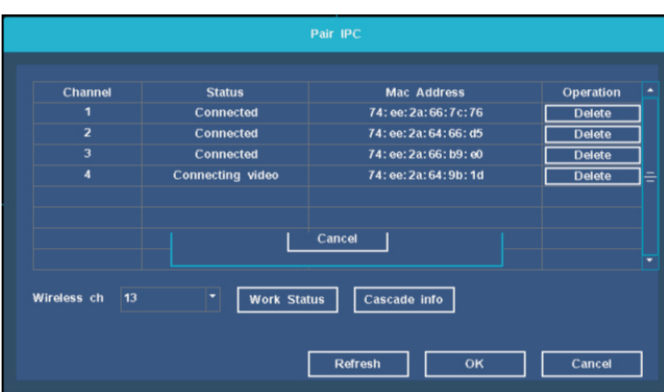

10

IPC Pairing

2. Wireless Working Status

Function Description: Check the network status of all IPCs and NVR in the IPC channel.

Steps: In the IPC pairing interface, click the [Work Status] button to complete the wireless status query. It can display Wi-Fi version information, Wi-Fi interference situation, Wi-Fi signal strength of each IPC channel. As shown below:

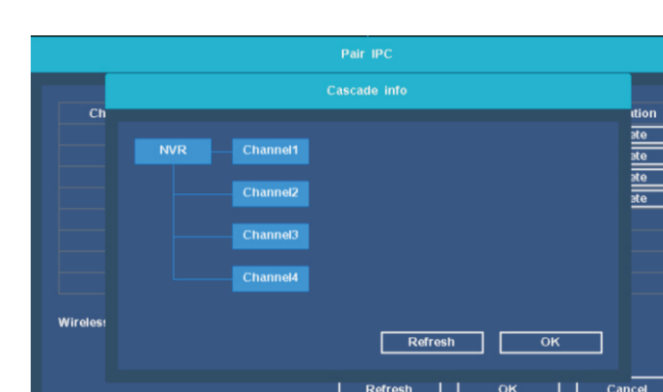

11

IPC Pairing



3. Cascading Information

Function Description: Used for relay cascading information of added IPC devices.

Steps: On the IPC pairing interface, click the [Cascade info] button to view the cascade information.

4. IPC Pairing

Function Description: Used to pair IPC devices and add cameras.

12

IPC Pairing

Steps: In the IPC pairing interface, find the unpaired channel, click the [Pair IPC] button, the interface displays a prompt box, pairing, long press 5s to add the paired IPC pairing button, the system prompts that the pairing is successful, is obtaining IPC information, click [OK] Button to complete the pairing and adding operation.

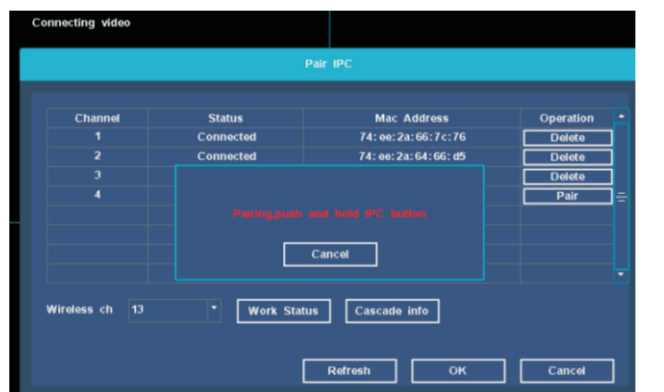

13

IPC Pairing

1. Network Settings

Function description: Network settings include: network card, DHCP switch, IP address, subnet mask, gateway, DNS settings. HTTP port, TCP port, P2P ID display, advanced settings.

[Net Card] Currently only supports wired network cards;

[DHCP Enable] After checking, automatically obtain the IP function (not recommended); Note: the device needs to be connected to the router. Unchecking requires the user to manually set the IP information.

[IP Addr] In manual mode, set the IP address of the device;

[Subnet Mask] In manual mode, set the subnet mask of the device;

[Gateway] In manual mode, set the default gateway of the device;

[DNS Settings] The domain name resolution server is

14

IPC Pairing

used to resolve the domain name into an IP address. The address is provided by the network operator where you are located. After setting the address, you need to restart to take effect;

[HTTP Port] The default is 80;

[TCP Port] The default is 6001;

[P2P ID] You can enable the NGTeco UUID/view the NGTeco account connection status.



15

IPC Pairing

[Advanced] NVR equipment NTP time, PPPoE setting, Email alarm setting, DDNS setting, Telnet service switch.

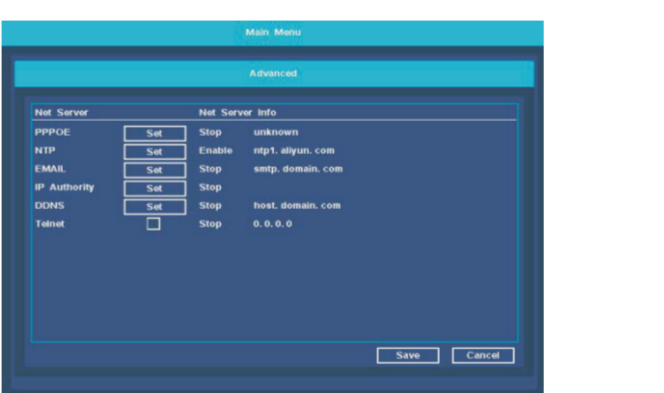

16

Mobile P2P Access

1. One-click Internet

Function description: enable or disable P2P remote function, check the status of tuyu P2P, APP download QR code, cloud ID QR code display, P2P users unbind.

Operation steps: On the NVR preview interface, click the [QR code] in the upper right corner of the mouse to open the [One Button Internet Access] interface. As shown below:



17

Mobile P2P Access

2. Mobile APP Access

Function description: Access the management device through the mobile phone APP.

Steps:

Step 1: Use the mobile phone to scan the QR code to download and install the Tuyu APP software;

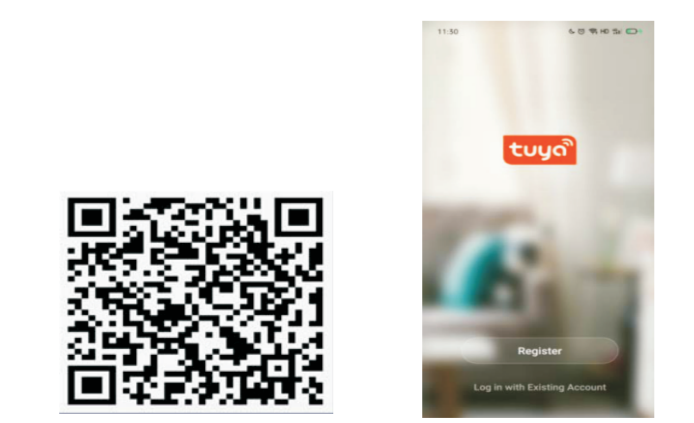

QR code for download the APP Interface of tuyu APP

18

Mobile P2P Access

Step 2: The first time you use the application, you will need to create a user ID. **Steps as follows:** Click the [Create New Account] button → check "Please read and agree to the relevant terms" to enter the registration interface → enter the mobile phone number or email address → enter the verification code → enter the set password → click the [Finish] button to register → after registration Log in to the main interface automatically.

Note: When you forget your password, please click [Forgot Password?] Button, follow the prompts to send the password to the registered mailbox.

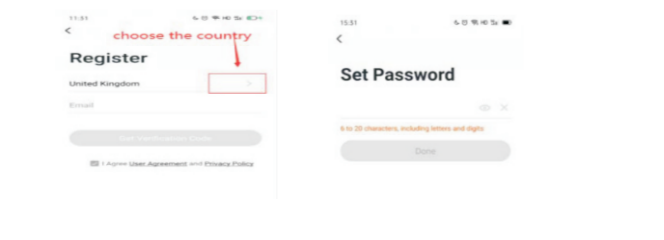

account register password setup

19

Mobile P2P Access

Step 3: Add devices. Click the upper right button on the main interface of Tuyu APP → click the [add device] button to enter into the "add device" interface → click the upper right button → Scan the cloud ID QR code on the NVR interface → Automatically add device after scanning successfully → click [Finish] adding successfully.

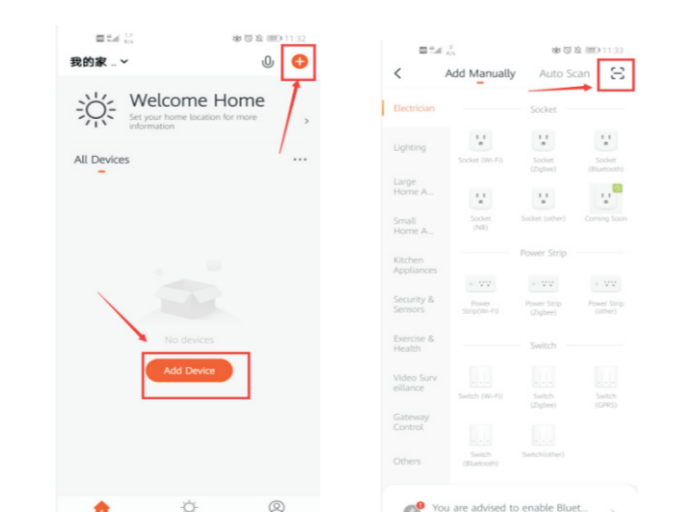

Add device interface Click the [Scan QR Code]

20

Mobile P2P Access

Step 4: Device preview and management operation interface.

Double-click the online device to browse the video of the online device. The functions of the buttons under the preview screen are as follow

Buttons	Function	Buttons	Function
[Device Info]	Device information and playback	[Play]	Play video in four windows
[Alarm Info]	Alarm information list	[Stop]	Stop
[Video Playback]	Video playback playback	[Settings]	Settings
[Cloud Storage]	Cloud storage service	[Video]	Video
[Channel Config]	Channel configuration	[SD/HD]	SD/HD

21

Mobile P2P Access

Double-click the online device to browse the video of the online device. The functions of the buttons under the preview screen are as follow

Double-click the online device to browse the video of the online device. The functions of the buttons under the preview screen are as follow

Buttons	Function	Buttons	Function
[Device Info]	Device information and playback	[Play]	Play video in four windows
[Alarm Info]	Alarm information list	[Stop]	Stop
[Video Playback]	Video playback playback	[Settings]	Settings
[Cloud Storage]	Cloud storage service	[Video]	Video
[Channel Config]	Channel configuration	[SD/HD]	SD/HD

22

HD NVR KIT